

To: Digi - Key

Issue No. : EFJ-C060530-04H

Date of Issue : May 30.2006

Classification : New Changed

PRODUCT SPECIFICATION FOR APPROVAL

Product Description : Ceramic Resonator
Product Part Number : EFJC3385B5B(Bulk type)
EFJC3385E5B(Taped type)

Customers Part Number :
Country of Origin : Indonesia(marked on packing label by English)
Applications :

※If you approve this specification, please fill in and sign the below and return 1copy to us.

Approval No	:	
Approval Date	:	
Executed by	:	

		(signature)
Title	:	
Dept.	:	

Capacitor Business Unit
Panasonic Electronic Devices Co.,Ltd
25.Kohata-nishinaka..Uji City , Kyoto, Japan

Prepared by : Engineering Section
Phone : +81-123-22-8769 (Direct)
Fax : +81-123-22-9484 (Direct)

Phone : +81-774-32-1111(Representative)

Contact Person : *H. Matsuno*
Title : Engineer

Authorized by : *[Signature]*
Title : Manager of Engineering

If there is a question, please ask the engineering section about it directly.

Panasonic

1. Scope

This Specification relates to the ceramic resonator intended to be used as time base oscillator of a microcomputer, microcontroller etc.

2. Appearance and Size

Item	Specification
2.1 Appearance	No remarkable damage or dirt
2.2 Shape/Size	As per Fig.1 attached
2.3 Marking	Frequency code, date code as per Fig.1 attached

3. Electrical Performance

Item	Specification
3.1 Nominal Oscillating frequency(f ₀)	33.868MHz
3.2 Frequency initial tolerance	±0.5% max.
3.3 Loop gain (G)	10dB min.
3.4 Built-in Load Capacitance(C1, C2)	8pF (ref)
3.5 Withstanding voltage	DC 50V, 1minute max.
3.6 Rated Working Voltage (1) Maximum input DC voltage (2) Maximum input AC voltage	DC 6V 10Vp-p
3.7 Insulation Resistance	500MΩ min. A voltage of 10V d.c. shall be applied for 1 min, after which measurement shall be made between terminals.
3.8 Operating temperature range	-20C to +80C
3.9 Storage temperature range	-40C to +85C

3.10 Frequency shift by Temperature (-20C to +80C)	±0.2%max. (from initial value)
3.11 Secular Change of frequency (for 10 years)	±0.2%max. (from initial value)

4. Mechanical Performance

Item	Test Condition	Specification
4.1 Random Drop	Three times random drop from the height of 1m onto concrete floor	The measured value shall meet Table 1.
4.2 Vibration	Vibration Amplitude of 1.5mm with 10 to 55Hz band, each of X,Y,Z directions for 2 hours	The measured value shall meet Table 1.
4.3 Bend Strength	Soldered onto the center of 1.6mm thick PCB which is laid on the 2 small supporters spaced 90mm. PCB is deflected to 1mm below and held 10±0.5 second with 1mm/sec.	The measured value shall meet Table 1.
4.4 Resistance to soldering heat	Two times heat stresses with following profile 1. Pre-heating: 175±5C; 60 to 120seconds 2. Keep-time over 220C; 20sec.max Peak temperature; lower than 250C	The measured value shall meet Table 1.

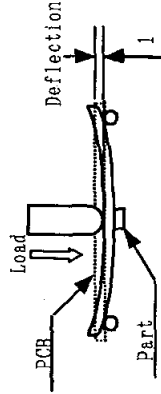

CLASSIFICATION	SPECIFICATIONS	Date	APPROVAL	CHECK	DESIGN
Part name	Ceramic Resonator	May 30, 2006			
Part No.	Bulk Type	EFJC3385B5B			
	Taped Type	EFJC3385E5B			
Spec No.	151S-EFJ-CA01-3385-01E				K. Matsume

4.5 Solderability	Terminals are immersed in rosin and immersed in soldering bath of 230±5C for 3±0.5 seconds	75% min. terminals shall be wet with new solder.
-------------------	--	--

5. Environmental Performance

Item	Test Condition	Specification
5.1 Dry heat test	Placed in a chamber with 85±2C for 1000hr	The measured value shall meet Table 1.
5.2 Cold test	Placed in a chamber with -40±3C for 1000hr	The measured value shall meet Table 1.
5.3 Damp heat	Placed in a chamber with 90 to 95% RH at 60±2C for 500hr	The measured value shall meet Table 1.
5.4 Heat cycle	100cycles heat stresses with following profile 85±3C 30minutes, 1 to 2 minutes transit time, -40±3C 30minutes	The measured value shall meet Table 1.

6. Measuring method

6-1 Oscillating frequency

See Figure 2.

6-2 Loop gain

Connect a product to the loop gain test circuit in Fig.3, and when inputting the specified sweep signal into the input terminal measure the maximum value of the This value shall be expressed in dB. the nominal frequency.

6-3 Measuring condition

20±2C, 60 to 70 % RH, 860 to 1060 hPa as a rule; however, if there occurs no doubt about judgement, the test may be performed at 5 to 35 C and 40 to 80% RH.

As for Resistance to soldering heat, Dry heat test, Cold test, Damp test and Heat cycle, resonator shall be measured after being placed in natural condition for 2 hours.

7. Packaging

7.1 Bulk type

1) Packaging quantity

A package shall contain 500 pieces.

Part Number, Quantity, Lot No. and

Manufacturer's Name shall be marked on the package side.

2) Packaging method

The package shall be no mechanical damage on resonators during transportation and/or in storage.

Table 1

Item	Specification after Test
Oscillating frequency	±0.3%max. (from initial value)
Loop gain	±3dBmax. (from initial value)

7.2 Taped type

- 1) Dimension of Carrier Tape See Figure 4.
- 2) Dimension of Reel See Figure 5.
- 3) Taping method The feeding holes shall be to the right side as the tape is pulled toward the user.
- 4) Packaging quantity A reel shall contain 3000 pieces. Part Number, Quantity, Lot No. and Manufacturer's Name shall be marked on the reel side.

8. Marking

- Side of Reel (Marking shall be on one side)
 - 1) Part name 2) Part number 3) Quantity 4) Maker name
 - 5) Country of origin (marked in English)

Packaging box

- 1) Part name 2) Part number 3) Quantity 4) Maker name
- 5) Country of origin (marked in English)

9. Production Plant

P.T. Panasonic Electronic Devices Indonesia Made in Indonesia

Fig.1

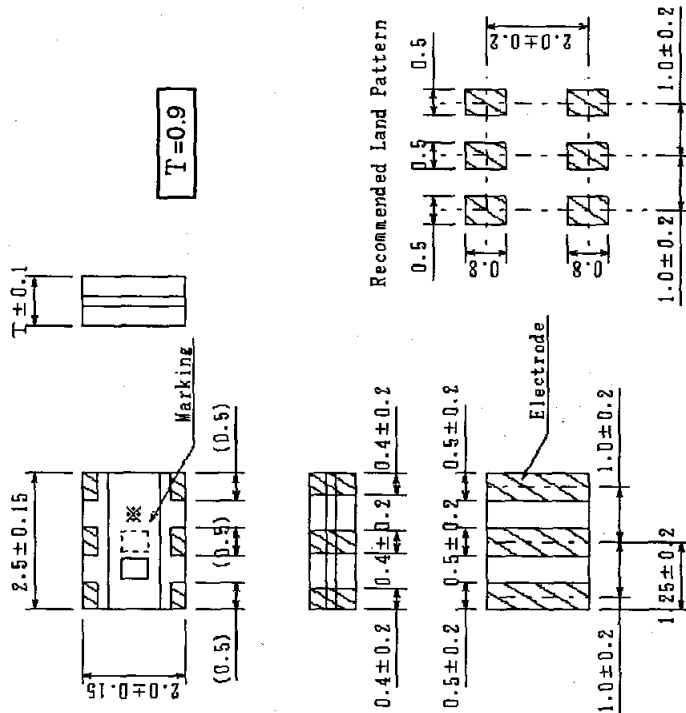

Marking Method

- This Mark represents the first two digits of nominal oscillating frequency following by Table 2.

Table 2

		Second digit of frequency									
		0	1	2	3	4	5	6	7	8	9
First digit of frequency	1	a	b	c	d	e	f	g	h	i	j
	2	k	l	m	n	o	p	q	r	s	t
	3	u	v	w	x	y	z	A	B	C	D
	4	E	F	G	H	I	J	K	L	M	N
	5	O	P	Q	R	S	T	U	V	W	X

- Individual Specification
- * EIAJ Monthly Code

Fig.2 Test circuit of oscillating frequency

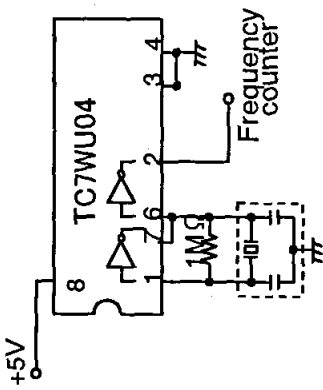

Fig.3 Test circuit of loop gain

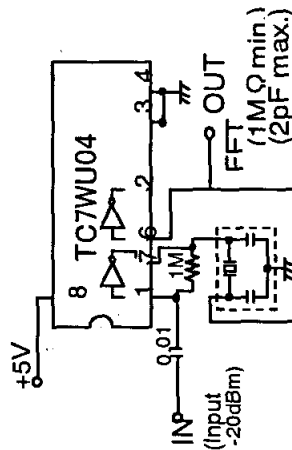
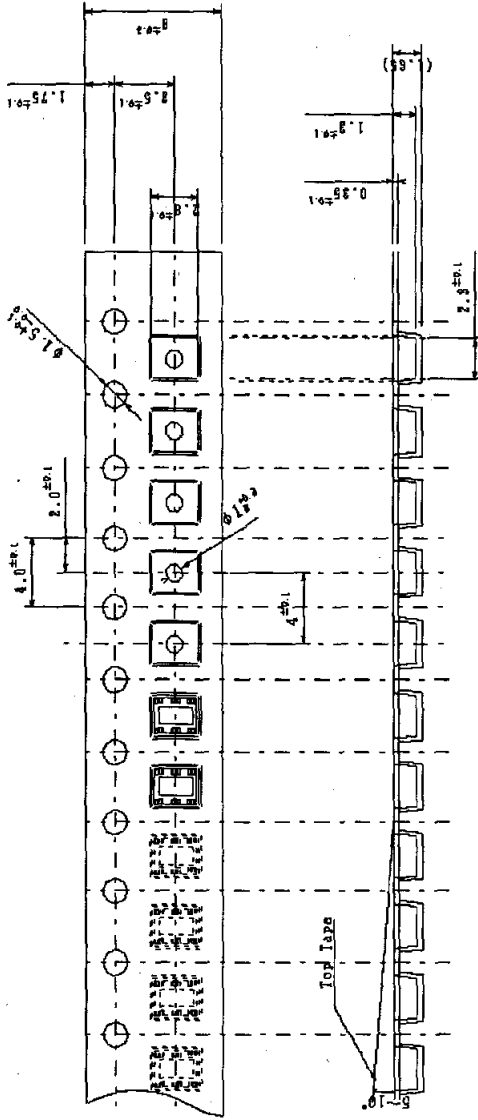

Figure 4. Dimension of Carrier Tape



The top tape peel strength force
0.19 to 0.69N(20 to 70gr)

The top tape peel speed 300mm/min.

Figure 5. Dimension of Reel

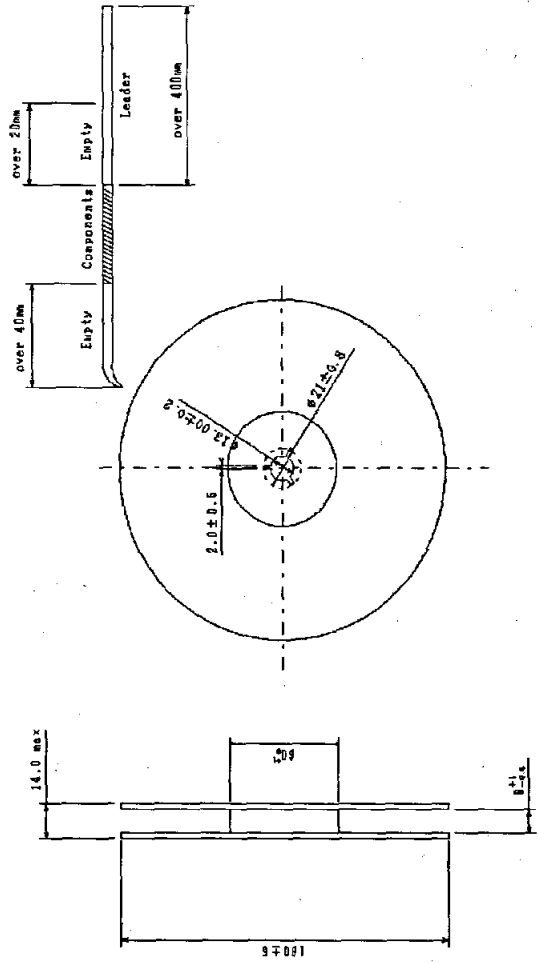

10. Precautions for Handling

10.1 Limitation of Application

This ceramic resonator is manufactured and sold for use in general electric of AV, home appliance, OA, communication, measuring equipment etc.
 So please contact us before using this product for the equipment which needs especially high reliability such as medical equipment, automobiles, trains, ship, disaster prevention and crime prevention equipment.

10.2 Δ Matters to be strictly observed

10.2.1 Fail-safe Design for Equipment

Be sure to provide appropriate fail-safe function on your equipment to prevent a second damage that may be caused by an abnormality or failure of the Ceramic Resonators.

10.2.2 Flow soldering shall not be applied to the Ceramic Resonators.

Soldering iron under 300C shall be placed 0.5mm off from product electrode within 3 seconds.

10.2.3 Rosin-based and non-activated flux shall be used. The content of halogen in the flux shall be 0.1wt% or less.

Water washable type flux shall not applied to the Ceramic Resonators.

10.2.4 "Ultrasonic Cleaning" and "Ultrasonic Welding" shall not be applied to the

Ceramic Resonators for preventing them from electrical failures and mechanical damages.

10.2.5 Be sure not to use the Ceramic Resonators beyond the specified "Operating Temperature Range" in the Specifications.

10.3 Application Notes

10.3.1 Abnormal/excess mechanical stresses such as falling shocks shall not be applied to the Ceramic Resonators in handling, to prevent them from being damaged or cracked. So, dropped devices shall not be used.

10.3.2 The Ceramic Resonators may be damaged by excess mechanical stress in automated assembly on PCB. So please practice an assembly test beforehand by this product and your machine. Automated assembly machine using mechanical chuck shall not be applied for this product and low speed assembly shall be recommended.

10.3.3 Soldering onto PCB and washing

1) Reflow Soldering Temperature and Time
 Solder within the temperature and time condition illustrated by the hatched zone in the Fig 6.

2) Standard Reflow soldering condition

1. Pre-heating ; 175±5C ; 60 to 120 seconds
2. Keep-time 20sec.max. at 220C ; Peak temperature ; lower than 250C

Fig.6 Reflow Soldering Temperature and Time

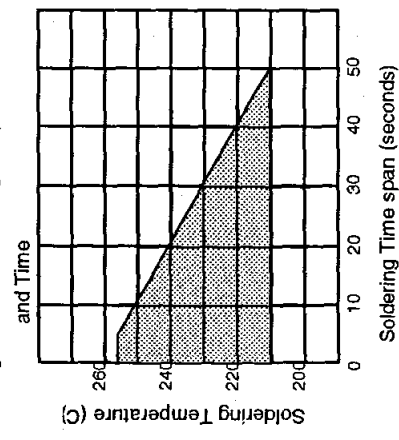
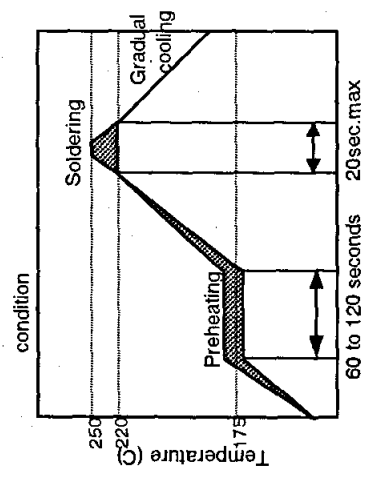

Fig.7 Standard Reflow soldering condition



3) Manual soldering by soldering iron

Soldering iron under 300°C shall be placed 0.5mm off from product electrodes within 3seconds.

10.3.4 Irregular or stop of oscillation may occur depending on the circuit design (applied IC, stray capacitance and insulation resistance on PCB etc.) and/or environmental conditions.

Please contact us beforehand.

10.3.5 It shall be noted that oscillating frequency of the Ceramic Resonator may drift depending on IC applied (the type names, the manufacturer) and the circuit design.

Please contact us beforehand.

10.3.6 Avoid the usage and storage of this product under the following circumstance.

- * in erosive gas
- * at the place exposed to water
- * in high humidity
- * at the place exposed to sea [salt] breeze

10.3.7 When placing the resonator on a warp-prone section or near a splitting slot of a PCB place the resonator so that no stress will be applied to it in the event of warp of a PCB board.

11. Notification matter

11.1 Applied law and restriction.

- 1) This product has not been manufactured with any ozone-depleting chemical controlled under the Montreal Protocol.
- 2) This product complies with the RoHS Directive (Restriction of the use of certain Hazardous Substances in electrical and electronic equipment (DIRECTIVE 2002/95/EC)).
- 3) All the materials used in this part are registered materials under the Law Concerning the Examination and Regulation of Manufacture, etc. of Chemical Substances.